







线缆型号	适用马达	适用放大器
ASD-B3PW00①② ASD-B3PW01①② ASD-B3EN00①②	ECM-B3L-C_0401__	ASD-B3
	ECM-B3M-C_0602__	
	ECM-B3M-C_0604__	
	ECM-B3M-C_0804__	
	ECM-B3M-C_0807__	
ASD-B3PW10①②	ECM-B3M-C_1310__	
	ECM-B3M-C_1315__	
	ECM-B3M-C_1320__	
ASD-B3EN10①② ASD-B3BK10①②	ECM-B3M-C_1310__	
	ECM-B3M-C_1315__	
	ECM-B3M-C_1320__	
	ECM-B3M-C_1820__	
	ECM-B3M-C_1830__	
ASD-B3PW20①②	ECM-B3M-C_1820__	
	ECM-B3M-C_1830__	
ASD-B3EN10①② ASD-B3BK10①②	ECM-B3M-C_1310__	
	ECM-B3M-C_1315__	
	ECM-B3M-C_1320__	
	ECM-B3M-C_1820__	
	ECM-B3M-C_1830__	
ASD-B2PW00①② ASD-B2EN00①② ASD-B2PW01①②	ECMA-C_0401_S(100W)	
	ECMA-C_0602_S(200W)	
	ECMA-C_0604_S(400W)	
	ECMA-C_0604_H(400W)	
	ECMA-C_0804_7(400W)	
	ECMA-C_0807_S(750W)	



	ECMA-C_0807_H(750W)	
	ECMA-C_0907_S(750W)	
	ECMA-C_0910_S(1000W)	
ASD-B2PW10①②  ASD-B2PW11①②	ECMA-G_1303_S(300W)	ASDA-B2
	ECMA-E_1305_S(500W)	
	ECMA-G_1306_S(600W)	
	ECMA-G_1309_S(900W)	
	ECMA-C_1010_S(1000W)	
	ECMA-E_1310_S(1000W)	
	ECMA-E_1315_S(1500W)	
	ECMA-C_1020_S(2000W)	
	ECMA-E_1320_S(2000W)	
	ECMA-F_1308_S(850W)	
	ECMA-C_1330_4(3000W)	
	ECMA-F11313_S(1300W)	
	ECMA-F11318_S(1800W)	
	ASD-B2EN10①②	
ECMA-E_1305_S(500W)		
ECMA-G_1306_S(600W)		
ECMA-G_1309_S(900W)		
ECMA-C_1010_S(1000W)		
ECMA-C_1310_S(1000W)		
ECMA-E_1315_S(1500W)		
ECMA-C_1020_S(2000W)		
ECMA-E_1320_S(2000W)		
ECMA-F_1308_S(850W)		
ECMA-C_1330_4(3000W)		
ECMA-F F11313_S(1300W)		
ECMA-F11318_S(1800W)		
ECMA-E_1820_S(2000W)		



ECMA-E\_1830\_S (3000W)

ECMA-F\_1830\_S (3000W)

型号	2D外形图	型号名称
ASD-B3PW00①②		台达B3小功率动力线
ASD-B3EN00①②		台达B3小功率编码线
ASD-B3PW01①②		台达B3小功率动力线带 刹车线

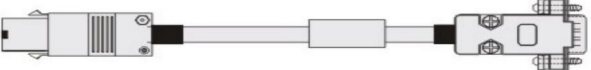
<p>ASD-B3PW10①②</p>	 <p>The image shows a power cable with a 90-degree angled connector on the left and a multi-pin connector on the right.</p>	<p>台达B3大功率动力线 (2000W适用于130mm电机框架)</p>
<p>ASD-B3EN10①②</p>	<p>外形图B</p>  <p>The image shows a cable with a connector on the left and a multi-pin connector on the right, labeled as '外形图B'.</p>	<p>台达B3大功率编码线</p>
<p>ASD-B3BK10①②</p>	 <p>The image shows a cable with two multi-pin connectors on the left and a multi-pin connector on the right.</p>	<p>台达B3大功率刹车线</p>

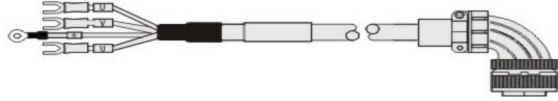
ASD-B3PW20①②	 A power cable with a 3-pin IEC connector on the left and a 4-pin terminal block on the right.	台达B3大功率动力线 (2000W适用于180mm电机框架)
ASD-B2PW00①②	 A power cable with a 4-pin terminal block on the left and a 4-pin terminal block on the right.	台达B2小功率动力线
ASD-B2EN00①②	 An encoder cable with a 5-pin connector on the left and a 5-pin connector on the right.	台达B2小功率编码线

ASD-B2PW01①②	 A cable with a multi-pin connector on the left and a single-pin connector on the right.	台达B2小功率动力线带 刹车线
ASD-B2PW10①②	 A cable with a multi-pin connector on the left and a multi-pin connector on the right.	台达B2大功率动力线
ASD-B2EN10①②	 A cable with a multi-pin connector on the left and a multi-pin connector on the right.	台达B2大功率编码线

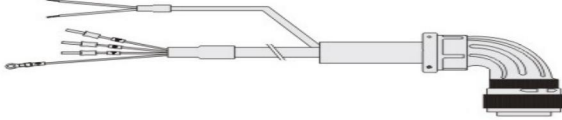
ASD-B2PW11①②		台达B2大功率动力线带 刹车线
--------------	--	--------------------

备注
<p>台达B3系列750w以下不带刹车电机伺服线组成:动力线+编码器线</p> <p>台达B3系列750w以下带刹车电机伺服线组成:动力线+编码器线+刹车线(动力线与刹车线是一体的)</p> <p>台达B3系列1-3KW以下不带刹车电机伺服线组成:动力线+编码器线 (2KW电机动力线需要适合电机框架)</p> <p>台达B3系列1-3KW以下带刹车电机伺服线组成:动力线+编码器线+刹车线 (2KW电机动力线需要适合电机框架)</p> <p>台达B2系列750w以下不带刹车电机伺服线组成:动力线+编码器线</p> <p>台达B2系列750w以下带刹车电机伺服线组成:动力线+编码器线+刹车线(动力线与刹车线是一体的)</p> <p>台达B2系列1-2KW以下不带刹车电机伺服线组成:动力线+编码器线</p> <p>台达B2系列1-2KW以下带刹车电机伺服线组成:动力线+编码器线+刹车线 (动力线与刹车线是一体的)</p>